

Attn: \_\_\_\_\_

**Pier Pleasure® Frame  
Specification Sheet**

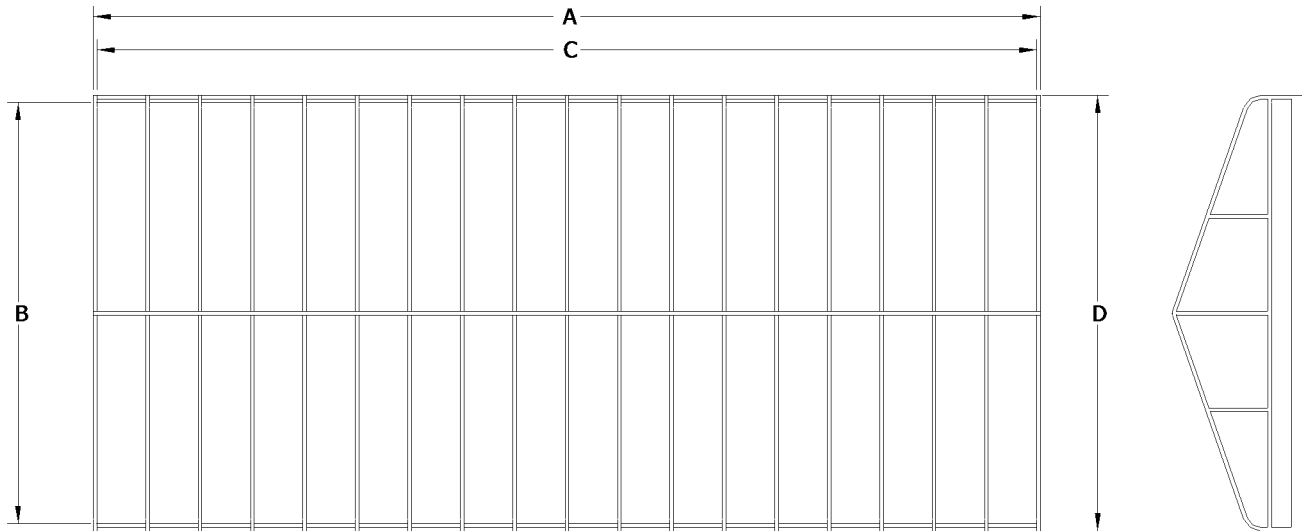

**\*ALL MEASUREMENTS (±1")**

PART NO.	SIZE	OVERALL LENGTH "A"	INSIDE WIDTH "B"	SIDE RAIL LENGTH "C"	OUTSIDE WIDTH "D"
PP1400096	14' X 96"	14'	99"	13' 8"	102"
PP1600096	16' X 96"	16'	99"	15' 8"	102"
PP1800096	18' X 96"	18'	99"	17' 8"	102"
PP2000096	20' X 96"	20'	99"	19' 8"	102"
PP2200096	22' X 96"	22'	99"	21' 8"	102"
PP1800108	18' X 108"	18'	111"	17' 8"	114"
PP2000108	20' X 108"	20'	111"	19' 8"	114"
PP2200108	22' X 108"	22'	111"	21' 8"	114"
PP2400108	24' X 108"	24'	111"	23' 8"	114"
PP2600108	26' X 108"	26'	111"	25' 8"	114"
PP1200114	12' X 114"	12'	117"	11' 8"	120"
PP1400114	14' X 114"	14'	117"	13' 8"	120"
PP2200114	22' X 114"	22'	117"	21' 8"	120"
PP2400114	24' X 114"	24'	117"	23' 8"	120"
PP2600114	26' X 114"	26'	117"	25' 8"	120"
PP2800114	28' X 114"	28'	117"	27' 8"	120"
PP3000114	30' X 114"	30'	117"	29' 8"	120"
PP2400120	24' X 120"	24'	123"	23' 8"	126"
PP2600120	26' X 120"	26'	123"	25' 8"	126"
PP2800120	28' X 120"	28'	123"	27' 8"	126"
PP3000120	30' X 120"	30'	123"	29' 8"	126"
PP3200120	32' X 120"	32'	123"	31' 8"	126"
PP3400120	34' X 120"	34'	123"	33' 8"	126"

**ATTACHMENT**

Continuous bungee is strung through d-rings and hooked to aluminum flat bar via s-hooks.

STANDARD VALANCE: 12" VALANCE

**OUTSIDE DIMENSIONS**

- A \_\_\_\_\_ OVERALL LENGTH OF FRAME
- B \_\_\_\_\_ INSIDE WIDTH OF FRAME
- C \_\_\_\_\_ LENGTH OF SIDE RAILS (W/O ENDS)
- D \_\_\_\_\_ OUTSIDE WIDTH OF FRAME

**CONTACT INFORMATION**

Name \_\_\_\_\_  
 Address \_\_\_\_\_  
 City \_\_\_\_\_ State \_\_\_\_\_ Zip \_\_\_\_\_  
 Phone \_\_\_\_\_ Fax \_\_\_\_\_  
 Boat Lift Brand \_\_\_\_\_

**NOTES**

---

---

---

---

---

---

---

---

**\*\*If dimensions don't match above,  
fill out detail sheet on page 2\*\***

Attn: \_\_\_\_\_

**Pier Pleasure® Frame  
Specification Sheet**

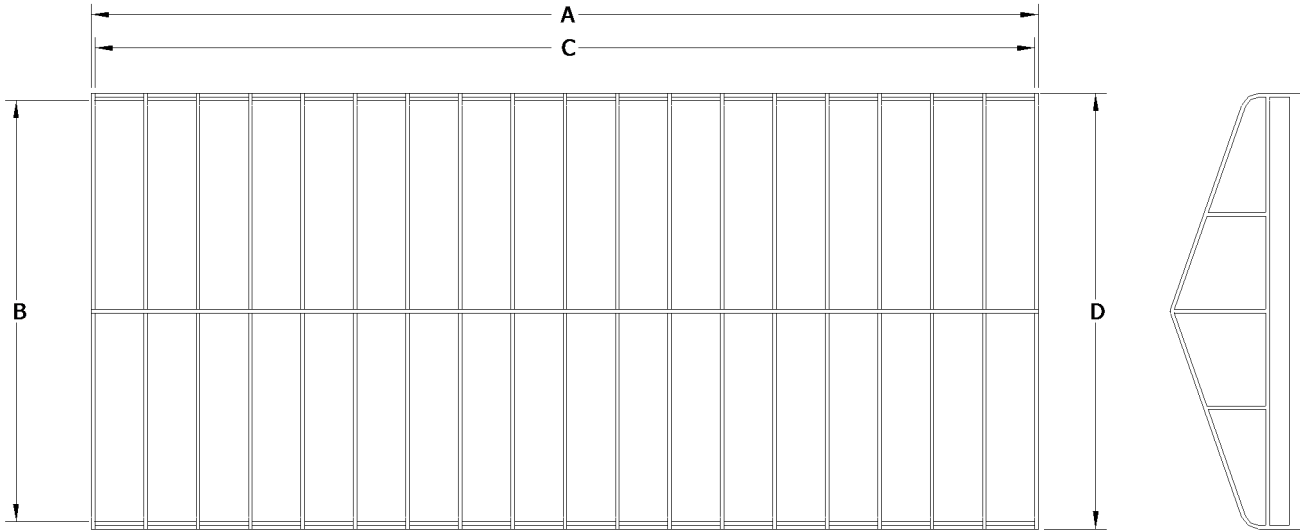

**\*ALL MEASUREMENTS (±1")**

**ATTACHMENT**

Continuous bungee is strung through d-rings and hooked to aluminum flat bar via s-hooks.

STANDARD VALANCE: 12" VALANCE

**OUTSIDE DIMENSIONS**

- A \_\_\_\_\_ OVERALL LENGTH OF FRAME
- B \_\_\_\_\_ INSIDE WIDTH OF FRAME
- C \_\_\_\_\_ LENGTH OF SIDE RAILS  
(W/O ENDS)
- D \_\_\_\_\_ OUTSIDE WIDTH OF FRAME

**CONTACT INFORMATION**

Name \_\_\_\_\_  
 Address \_\_\_\_\_  
 City \_\_\_\_\_ State \_\_\_\_\_ Zip \_\_\_\_\_  
 Phone \_\_\_\_\_ Fax \_\_\_\_\_  
 Boat Lift Brand \_\_\_\_\_

**NOTES**

\_\_\_\_\_  
 \_\_\_\_\_  
 \_\_\_\_\_  
 \_\_\_\_\_  
 \_\_\_\_\_

**\*\*If dimensions don't match above,  
fill out detail sheet on next page\*\***

REVISIONS				ISSUER
REV	ECN	DATE	DESCRIPTION	RML
A	EC-00852	5/29/2019	RELEASE	RML

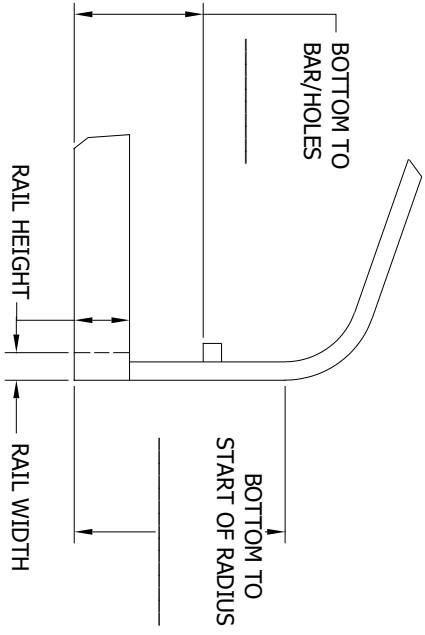
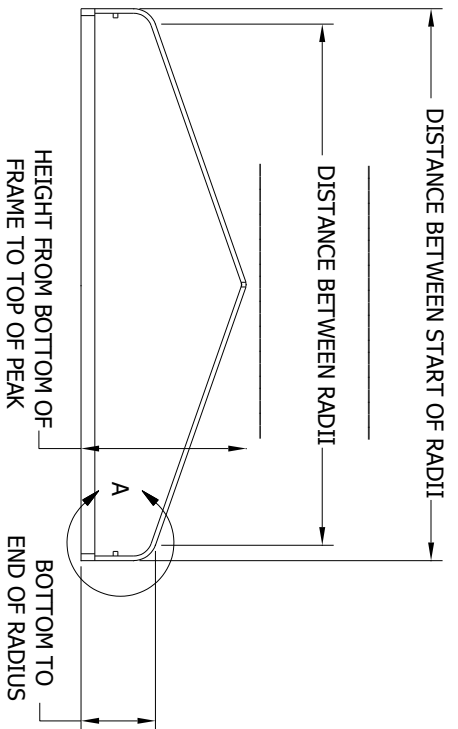

ATTACHMENT METHOD(S)

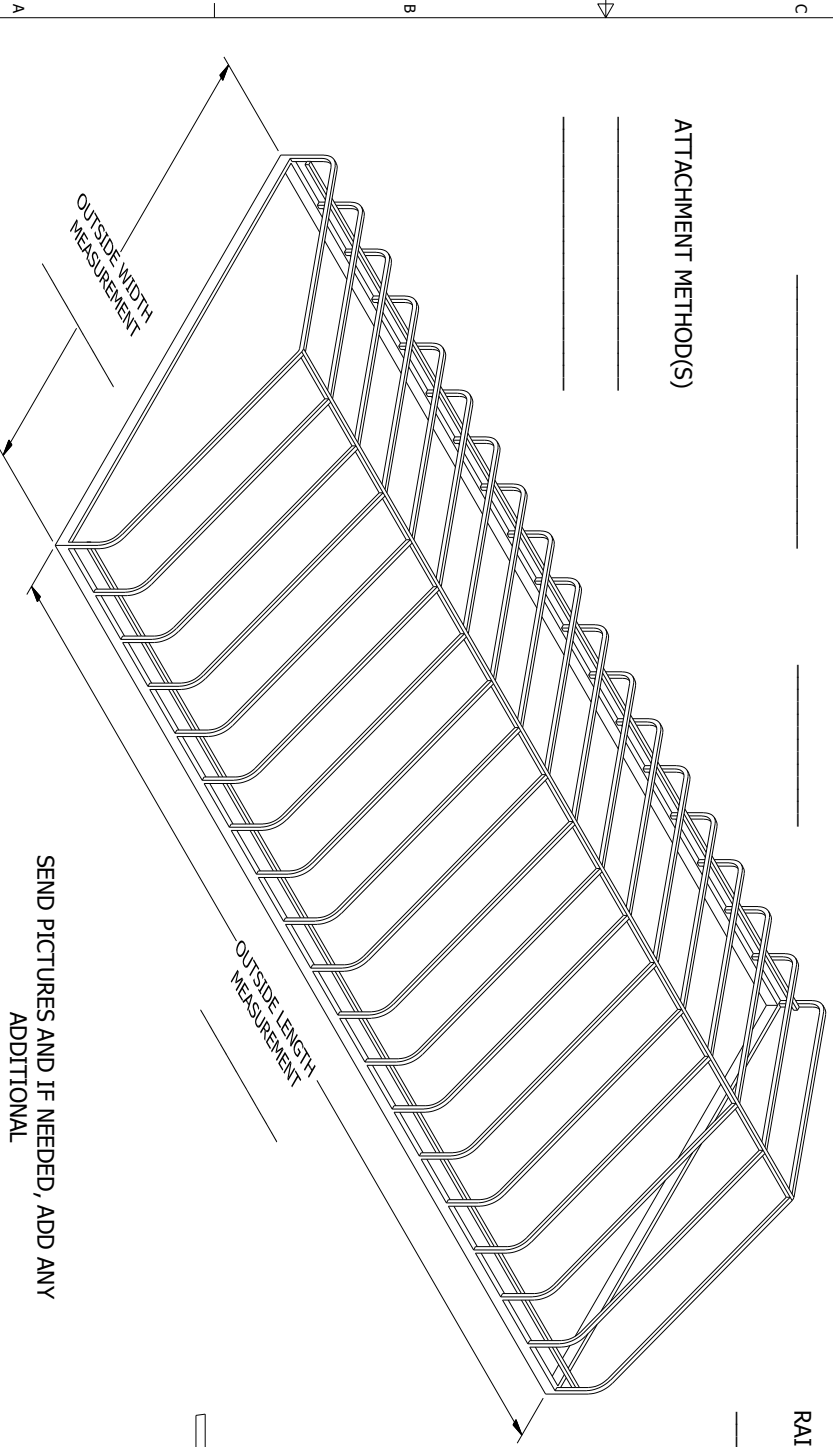

TOTAL NUMBER OF BOWS

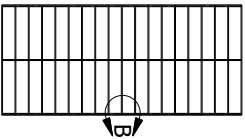

DETAIL B

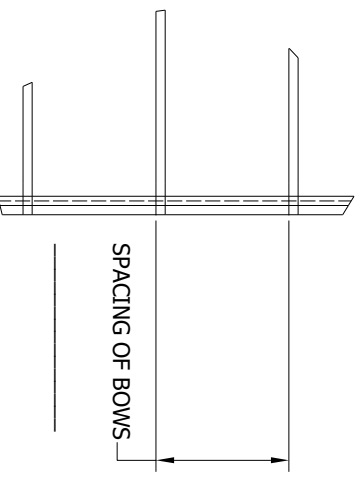

SEND PICTURES AND IF NEEDED, ADD ANY ADDITIONAL FEATURES OR SKETCH THE VIEWS ON A SECOND PAGE.

TOLERANCES - UNLESS NOTED

DECIMAL #  
FRACTION #  
ANGLE #

DWTT:	DATE	SCALE	SHEET	PART NO.
RML	10/4/2016		1	F-0199
ENGR:	DATE			
CRG	10/10/2016			

PEAKED FLUSHED END FRAME DETAIL SHEET

FEATURES OR SKETCH THE VIEWS ON A SECOND PAGE.

TITLE

SIZE

C